

DENKA Σ1000

Additive for Super High-Strength Concrete

Description

DENKA Σ1000 is a revolutionary additive used in the production of super high-strength concrete products. Formation of ettringite and calcium silicate hydrate is enhanced when **DENKA Σ1000** is used, imparting super high-strength in concrete.

Features

- Enables manufacture of high-strength concrete in short periods (85N/mm² in 72 hours with steam curing)
- Enhances resistance to freezing/thawing, weathering
- Useable in slurry form
- Allows for rapid production of concrete products to increase delivery efficiency
- Chloride-free

Applications

- Concrete piles
- Spun pipes
- Box culverts

Packaging

- 25kg paper bags
- 1,000kg bulk bags

Shelf Life

- 8 months from production date
- Determine the production date by reference to the lot number. A lot number of "1AXXX" corresponds to production in Jan 2001; "2BXXX" to Feb 2002 and so on.

Technical Information

Chemical Composition

Ig-loss (%)	SiO ₂ (%)	Al ₂ O ₃ (%)	Fe ₂ O ₃ (%)	CaO (%)	SO ₃ (%)
≤5	12-22	≤8	≤3	30-40	30-48

Physical Properties

Density (g/cm ³)	Specific surface area (cm ² /g)
≤2.5	≥5000

- Setting times

Dosage	0.0%	5.0%	7.5%	10.0%	12.5%
W/C	26.0%	25.6%	25.4%	25.0%	24.8%
Initial setting time	2h 28min	2h 26min	2h 25min	2h 23min	2h 22min
Final setting time	3h 33min	3h 35min	3h 40min	3h 54min	4h 00min

- Soundness properties

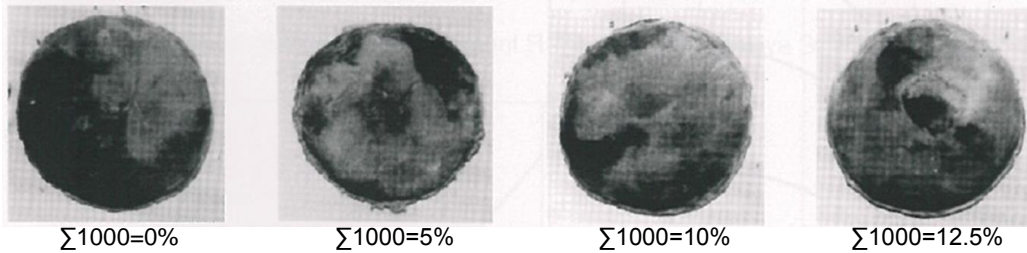

Soundness test (Pat test) done in accordance with JIS R-5201 boiling method.

Soundness shown to be good in both immersion and boiling tests done in accordance with JIS R-5201.

- Typical mix proportions

Gmax (mm)	Slump (cm)	s/a (%)	w/c (%)	OPC ¹ (kg/m ³)	Σ1000 ² (kg/m ³)	Water (kg/m ³)	Sand (kg/m ³)	Gravel (kg/m ³)	Superplasticizer (kg/m ³)
20	5	38	29	486	48.6	132	697	1154	7.2

¹DENKA cement

²Equivalent amount of sand replaced by Σ1000. No slump difference observed.

- Curing method

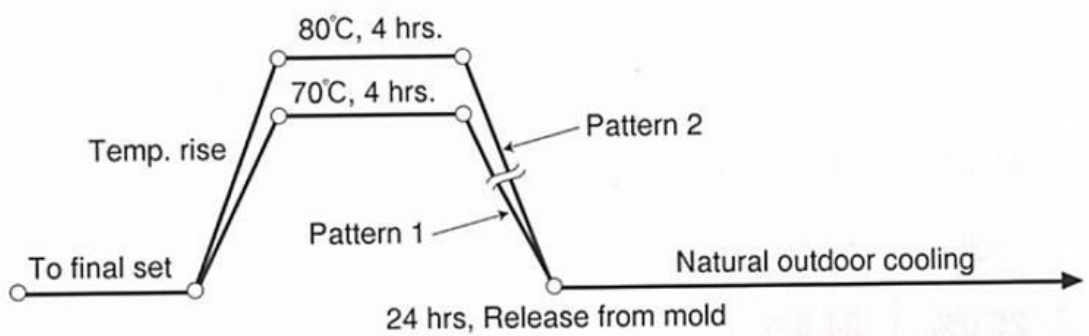

- Correlation between DENKA Σ1000 dosage % and compressive strength

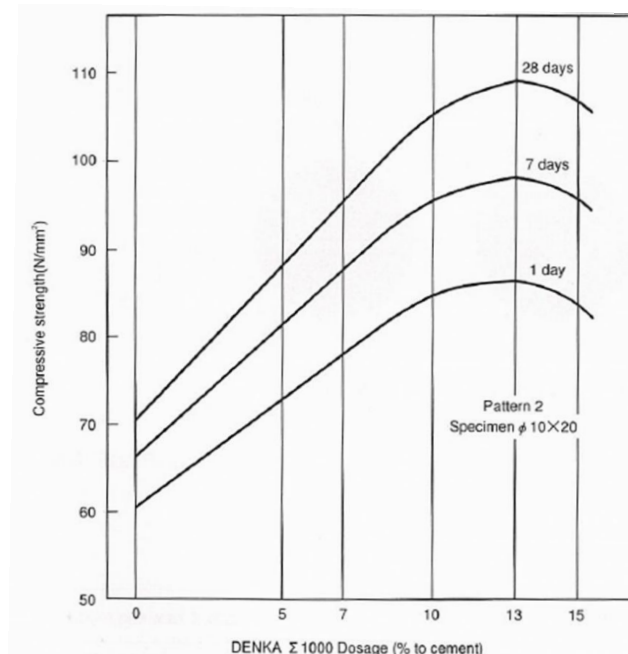

Optimum dosage of DENKA Σ1000 is 7~10% by cement weight.

Denka

- Correlation between steam curing temperatures and compressive strength

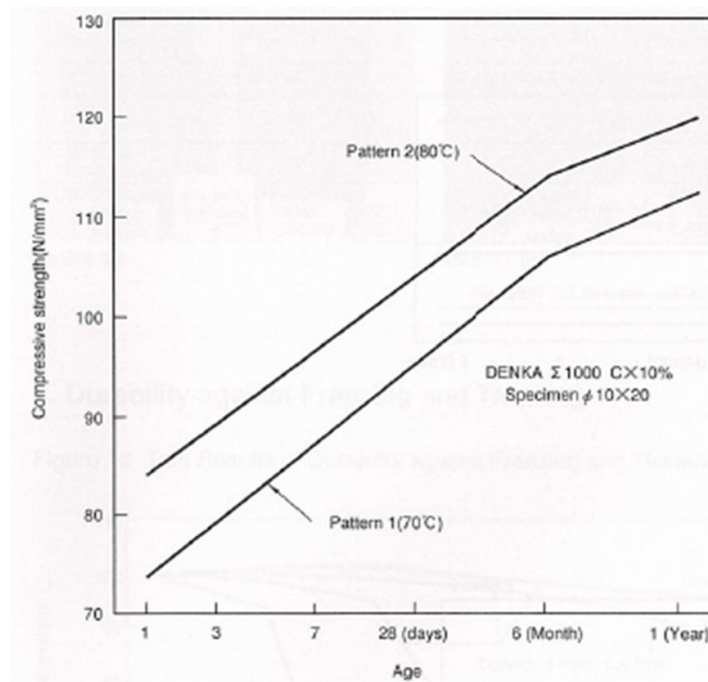

Temperatures of >70°C are recommended for curing concrete with **DENKA Σ1000**.

- Correlation between water cement ratio and compression strength

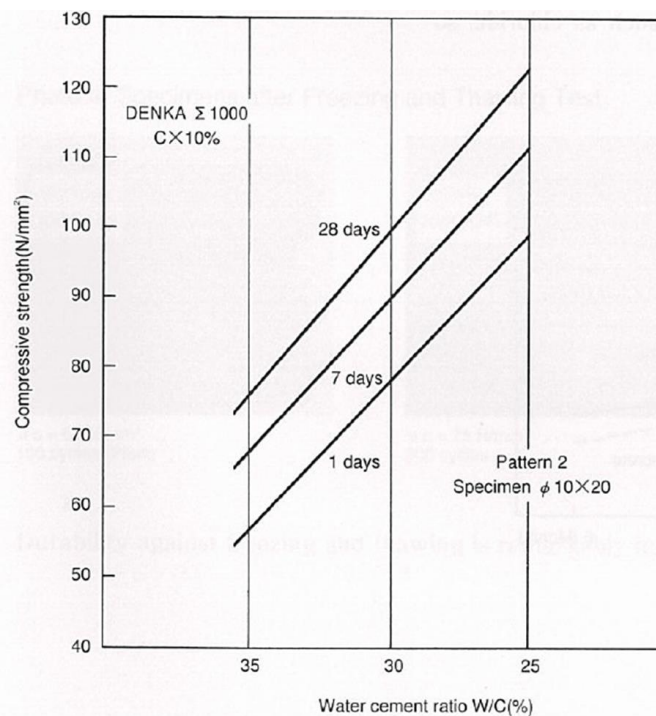

Compressive strength of cement containing **DENKA Σ1000** is shown to be inversely proportional to the water:cement ratio.

- Length change in concrete

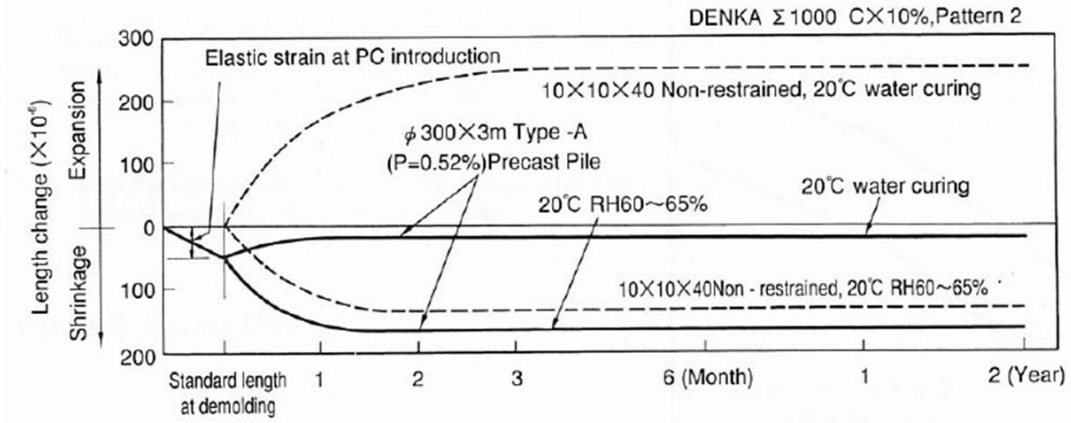

- Concrete pH

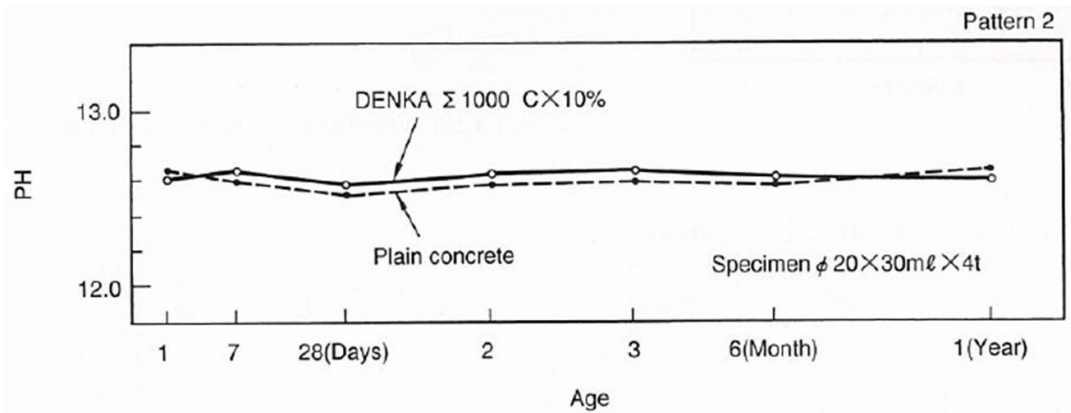

Alkalinity of concrete is not affected by the use of chloride-free **DENKA Σ1000**. As such, rusting will be minimized in any reinforcing bars used in the concrete.

- Acid-resistance

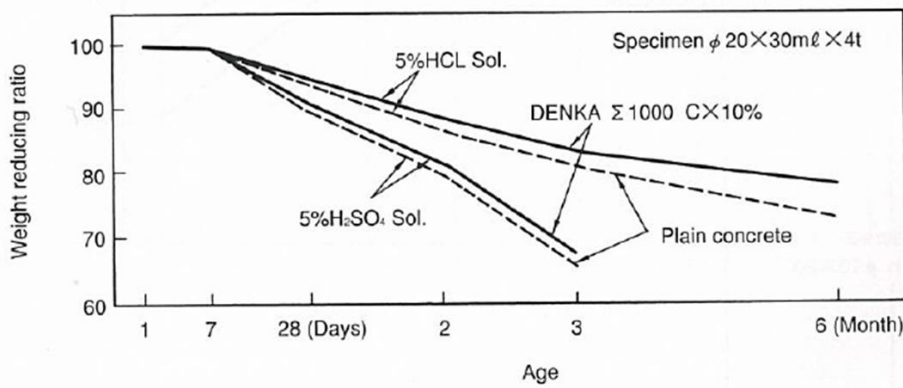
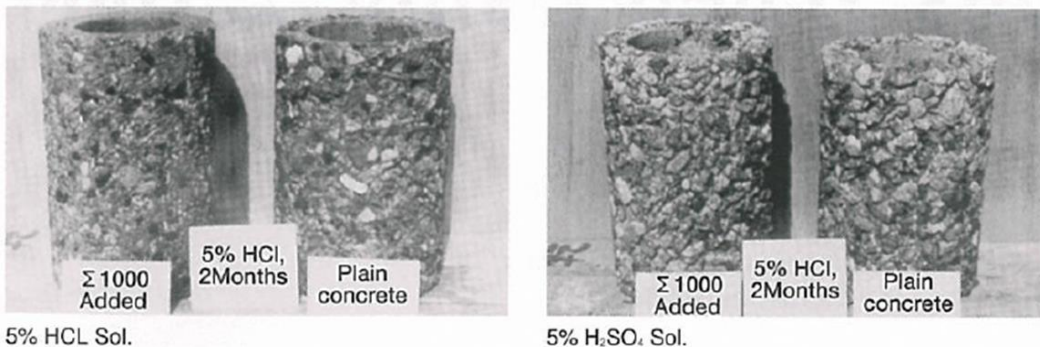

Figure showing cement ratio loss with time in 5% HCl solution and 5% H₂SO₄ solution.



Concrete specimens of the above test.

- Resistance to freezing/thawing (tests done in accordance with ASTM C-666)

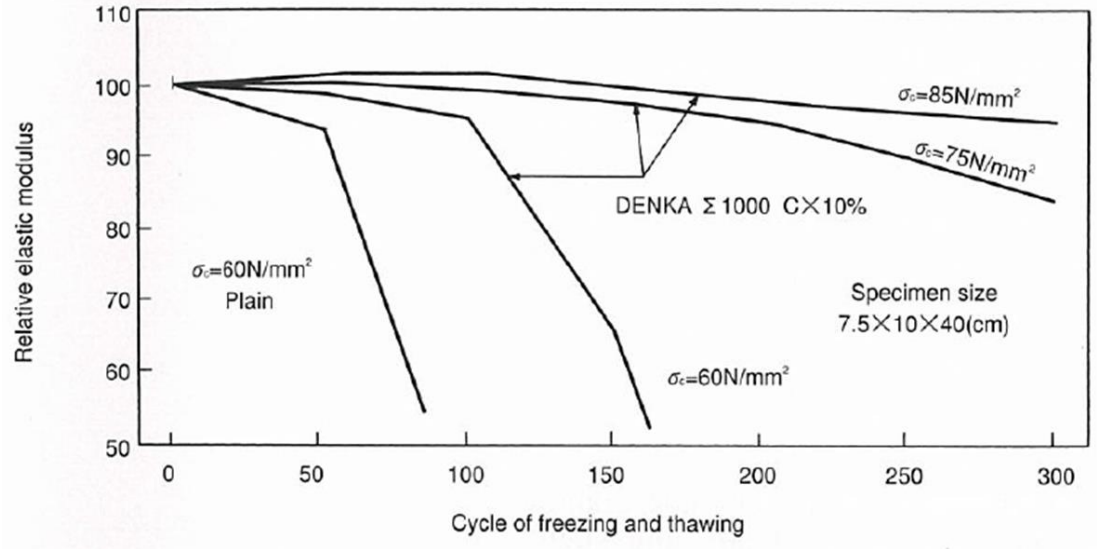
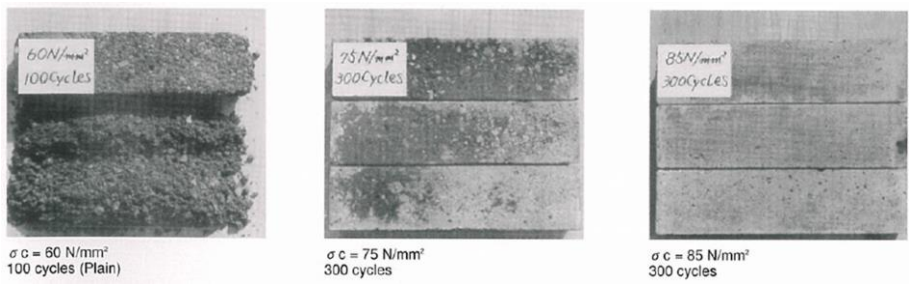

Figure showing relative elastic modulus of concrete samples with increasing exposure freezing/thawing exposure



Above photos show concrete specimens after being treated to repeated cycles of freezing / thawing. With the addition of **DENKA $\Sigma 1000$** , durability is greatly improved.

Application Examples

- Case Study 1: Prestressed Concrete Piles

Mix Proportions

Gmax (mm)	Slump (cm)	s/a (%)	w/c ³ (%)	OPC (kg/m ³)	∑1000 (kg/m ³)	Water (kg/m ³)	Sand (kg/m ³)	Gravel (kg/m ³)	Superplasticizer (kg/m ³)
20	5	38	29	486	48.6	132	697	1154	7.2

³(Water + Water-reducing agent) / OPC

Curing method:

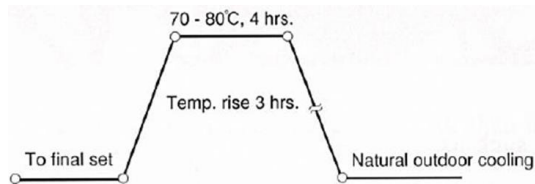

Test results:

Age	∑1000		Plain concrete	
	Day 1	Day 7	Day 1	Day 7
Compressive strength (N/mm ²)	84	94	58	67
Young's modulus (N/mm ²)	3.8 × 10 ⁴	4.5 × 10 ⁴	-	-
Flexural strength (N/mm ²)	7.5	9.0	5.2	6.4
Tensile strength (N/mm ²)	5.3	7.5	-	-

Pile performance:

Pile Dimensions			Prestressed steel bars		Pile cross-sectional area (cm ²)	Effective prestress		Flexural moment		Shear strength Qcr (t)	Bearing Capacity (t)
φ (mm)	Thickness (mm)	Type	φ (mm) X QTY	Cross-sectional area (cm ²)		Standard	Design	Mcr (t-M)	Mu (t-m)		
400	70	A	8×10	4.00	765.8	40	43	6.7	8.4	17.9	129
		B	10×14	8.96		80	85	9.2	17.8	23.3	132
		D	14×12	15.00		120	125	11.9	27.2	28.0	132
		F	14×16	20.00		160	165	14.6	33.0	32.4	126
600	100	A	8×20	8.00	1570	40	42	22.1	34.8	36.2	264
		B	10×28	17.92		80	85	30.5	55.3	47.4	270
		D	12×32	28.80		120	125	38.8	84.5	56.8	269
		F	14×32	40.00		160	165	47.7	111.2	65.8	259

- Case Study 2: Box culverts

Mix Proportions

Gmax (mm)	Slump (cm)	s/a (%)	w/c ³ (%)	OPC (kg/m ³)	∑1000 (kg/m ³)	Water (kg/m ³)	Sand (kg/m ³)	Gravel (kg/m ³)	Superplasticizer (kg/m ³)
25	12	38	32	460	36.8	141.7	658	1143	5.52

Curing method (with sheet):

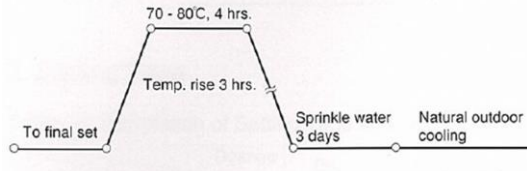

Rebar specifications:

Pile cap		Main bar				Side wall		Distributing bar		Slant bar					
H x W x L	t	φ	QTY	φ	QTY	φ	QTY	φ	QTY	φ	QTY				
1200 x 1200 x 1500	100	D13	10	D10	10	D13	10	D10	10	D10	10	D10	32	D10	40

Transverse section:

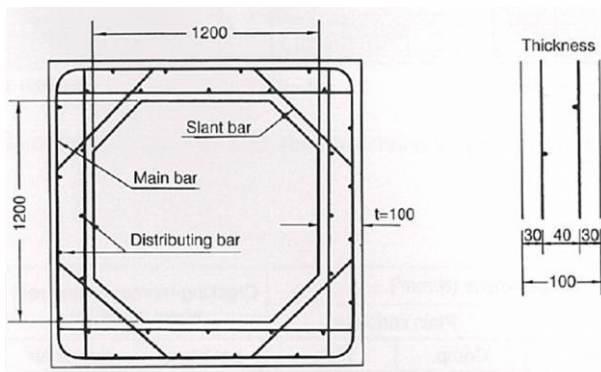

In the case of plain concrete, the specifications of the distributing bar are the same as above; the thickness of both the pile cap and the side wall is 16cm.

Test Results (Age: 7days):

Strength (N/mm ²)				Maximum load before cracking ⁴ (t)	
∑1000 added		Plain concrete		Designed load	∑1000 added
Compressive	Flexural	Compressive	Flexural		
75	6.8	50.3	4.5	10.4	11.5

⁴Load tests were done by applying a 50 x 20cm square timber load at a point.

• Case Study 3: Box culverts

Mix Proportions

Gmax (mm)	Slump (cm)	s/a (%)	w/c ³ (%)	OPC (kg/m ³)	∑1000 (kg/m ³)	Water (kg/m ³)	Sand (kg/m ³)	Gravel (kg/m ³)	Superplasticizer (kg/m ³)
25	2	40	31	460	36.8	137	700	1113	5.52

Curing method:

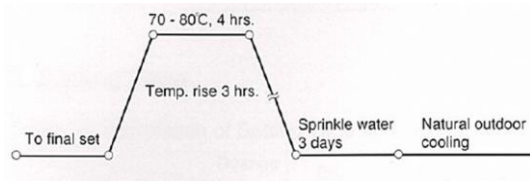

Transverse section:

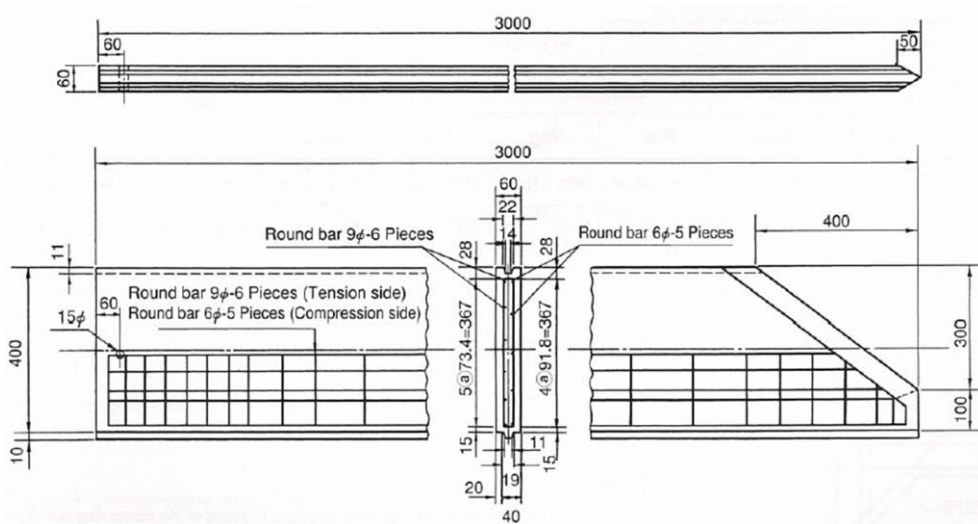

Test Results (Age: 7 days):

Age (days)	∑1000	Strength (N/mm ²)				Maximum moment before cracking (t-m)	
		Compression	Flexural	Plain concrete Compression	Plain concrete Flexural	per sheet	per meter
7	∑1000	79.5	7.2	53.5	4.8	0.37	0.95
28	Standard	>40	-	-	-	0.32	0.82

Handling Precautions

- Refer to Safety Data Sheet (SDS) before use.
- Water-Cement (w/c) ratio control
 - Control the water cement ratio properly to ensure concrete strength. For super high-strength concrete, w/c ratio should be lowered as far as possible with the use of super-plasticizers.
- Steam-curing conditions
 - A minimum of 2 hours is required for pre-curing. Pre-curing is highly recommended before final setting of concrete is carried out.
 - If curing is carried out before the concrete is completely set, physical thermal expansion may occur that which lowers the compressive strength of the concrete.
 - Carry out steam curing at 70°C for more than 4h. The greater the concrete maturity, the higher the strength achieved.
- Material selection
 - Concrete properties will differ depending on the characteristics of cement and aggregates. Conduct necessary trial tests and optimize concrete mix proportions.
 - Use of plasticizers will not affect the concrete strength so long as the w/c ratio is maintained.
- Wear protective gear (goggles, mask, gloves, and rubber boots) while handling the product. Do not dispose of the product in drains.
- Once opened, the product should be used up completely. Otherwise, reseal for storage.
- The product should be stored in a dry area, indoors, and out of direct sunlight.
- For further information, please contact DENKA.

Limitation of Liability

The information contained in this brochure provides general advice for potential customers of DENKA about the basic properties and characteristics of various DENKA products (hereafter referred to as "the Product Information"). DENKA makes no warranty or representation as to the entire accuracy or completeness of the Product Information in this brochure. Nothing in this brochure will be deemed to create any express or implied warranty or obligation of DENKA with respect to the Product Information or its use, including, but not limited to, any warranty of merchantability, fitness for a particular purpose, or infringement of any intellectual property rights. Each user of the Product Information and DENKA products assumes their own responsibility to properly determine the manner and suitability of use of the Product Information and DENKA products in its own operations. The user should exercise proper care in considering the Material Safety Data Sheet, Product Information and any other technical information provided by DENKA, including descriptions of the conditions of use, warnings, and other cautionary instructions. DENKA reserves the right to change the Product Information from time to time at its discretion and without notice.

Denka
<http://www.denka.co.jp/eng/>

Denka Co. Ltd.

Special Cement Additives Department
TEL: +81-3-3507-5465 FAX: +81-3-3507-5085

-China-

**DENKA INFRASTRUCTURE
TECHNOLOGIES SHANGHAI**
ROOM 2807, NEW HONGQIAO
CENTER BLDG
NO.83 LOUSHANGUAN RD,
CHANG NING AREA, SHANGHAI CHINA
TEL: +86-21-6236-5510
FAX: +86-21-6236-5505

-Asia-

**DENKA INFRASTRUCTURE
TECHNOLOGIES PTE LTD**
4 SHENTON WAY #29-02 SGX
CENTRE 2 SINGAPORE 068807
TEL: +65-6216-0580
FAX: +65-6224-3840

-Europe-

DENKA CHEMICALS GMBH
WEHRHAHN-CENTER, CANTADOR STR.3,
DUSSELDORF, GERMANY
TEL: +49-211-130990
FAX: +49-211-329942

5J01JP

Denka